

SolarPRO EZ POOL HEATER OWNER'S MANUAL

ENGLISH

MODEL 4530

IMPORTANT SAFETY RULES

Read all instructions BEFORE assembling and using
this product. KEEP THIS MANUAL.



IMPORTANT DO NOT RETURN PRODUCT TO STORE

For technical assistance and missing parts, call Customer Service toll-free

1.888.339.2546

(press 135 at any time)

Monday through Friday, 8:00 am to 5:00 pm MST

Please visit our website, www.game-group.com, for potential updates to these instructions.

IMPORTANT

**Approved for use with any filter pump up to a maximum of 3/4 HP.
Use of any other type of pump will void the warranty.**

**For filter pumps 3/4 HP or greater,
a GAME Bypass Kit is required (sold separately).**

CONNECTING MULTIPLE UNITS

**DO NOT install multiple units directly into the return line.
Doing so may damage the product and will void the warranty.**

**To install multiple units, you MUST use a GAME Bypass Kit,
available from your local swimming pool specialty retailer.
Contact GAME to receive a list of retail sources in your area.**

**If you wish further information regarding the installation
of multiple heaters, please contact GAME Customer Service
(1.888.339.2546 ext 135) or see your local swimming pool specialist.**

**YOUR POOL HEATER HAS BEEN ENGINEERED AND MANUFACTURED
TO OUR HIGHEST STANDARD FOR DEPENDABILITY, EASE OF OPERATION
AND SAFETY. THANK YOU FOR YOUR PURCHASE.**

TABLE OF CONTENTS

| | |
|---|----|
| 1. Safety Warnings | 4 |
| 2. General Information | 4 |
| 3. Parts List/Reference | 5 |
| 4. Installation Instructions | 6 |
| 5. Initial Operation | 7 |
| 6. Maintenance | 8 |
| 7. Troubleshooting | 8 |
| 8. Warranty | 9 |
| 9. Appendix: Exploded Parts Diagram | 10 |

**READ ALL INSTRUCTIONS BEFORE ASSEMBLING AND USING
THIS PRODUCT. FAILURE TO FOLLOW INSTRUCTIONS CAN CAUSE
SEVERE AND/OR FATAL INJURY.**

**IMPORTANT
DO NOT RETURN PRODUCT TO STORE**

For technical assistance and missing parts, call Customer Service toll-free

1.888.339.2546

(press 135 at any time)

Monday through Friday, 8:00 am to 5:00 pm MST

Please visit our website, www.game-group.com, for potential updates to these instructions.

1. SAFETY WARNINGS

READ ALL WARNINGS BELOW. FAILURE TO DO SO COULD RESULT IN SERIOUS PERSONAL INJURY OR DEATH.

- Carefully read and adhere to all CAUTION and NOTE notices located throughout this manual. Failure to comply with these instructions can cause serious injury, death, or damage to the unit.
- Do NOT allow children to operate this product.
- Always turn the filter system to a setting that does not allow flow to the pool return when installing or working on the solar heater.
- Install product away from the pool to prevent children from using the heater as a way to access the pool.
- NEVER service this unit with the pool pump running.
- Do not use any petroleum based lubricant. Petroleum based products will destroy plastic parts.

THESE CAUTION WARNINGS ARE NOT INTENDED TO INCORPORATE ALL POSSIBLE INSTANCES FOR RISK AND/OR SEVERE INJURY. THE POOL OWNER SHOULD ALWAYS EXERCISE CAUTION AND COMMON SENSE WHEN UTILIZING THEIR SWIMMING POOL AND OPERATING EQUIPMENT.

IMPORTANT: When connecting multiple solar heaters, a GAME bypass kit (sold separately) is required. Contact GAME Customer Service, 1.888.339.2546 for more information.

2. GENERAL INFORMATION

This manual provides information relating to the installation, utilization and maintenance of our solar heater. We recommend you read this manual in its entirety and keep it for future reference.

The solar heater you just purchased for your above ground pool is simple to install and effortless to operate once connected. The installation instructions included in this manual are based on a few assumptions: 1) you have an existing above ground pool that is completely set up and filled with water, 2) your above ground pool is equipped with a pump-operated water filtering system, and 3) you have the necessary hoses needed to feed water in and out of your pool and filter system.

These assumptions are necessary as the solar heater, once installed, will be completely dependent upon your pool's filter pump to push water in and through the heater's solar coils.

NOTE: Approved for use with any cartridge or sand filter up to 3/4 HP max or filter systems with flow rates less than 2,500 gallons/hour (11,365 liters/hour). Use of any other type of pump will void the warranty.

How It Works

When properly installed, the solar heater will be connected to your filter and your pool by two hose connections: One hose will feed cold, filtered pool water from your pump into one port of the solar heater. The other hose will feed sun warmed water from the other port of the solar heater to your pool via the pool return inlet in your pool. As cold water is fed into the solar heater, it travels through the solar coils where it is heated by the sun before it is delivered back into your swimming pool.

Unpacking Your Solar Heater

Carefully remove the product and all component parts from the box. Make certain all parts are present before beginning assembly (see Section 2, Parts List/Reference).

Tools & Equipment Required

The following items are not included with your new solar heater, but will be required for proper installation and operation:

- ¼" Flat head screwdriver
- Silicone based lubricant

Know Your Pool

Before you begin installation it is a good idea to know certain specifications about your pool:

- How big is your pool?
- How many gallons does it hold?
- What is your pump motor's power in watts? (i.e. 240W)
- What size hose does it use? (i.e. 1¼" dia, 1½" dia or 2¼" dia)
- What kind of hose connection does your pool use? (i.e. threaded/unthreaded)
- What location will position the heater for maximum sun exposure?

Solar Heater Location

Your solar heater needs to be located on a hard, level surface free of sharp objects which could puncture the heater. You will need to position the heater lower than the pool's water level and at a safe distance away from the pool (see Section 1, Safety Warnings). For best results and long life of the product, placing a tarp on the ground beneath the heater is recommended.

- The unit(s) should never be placed on the roof of any structure, or more than 60" above the water level of the pool.
- The unit should be positioned in an area which receives as much direct sunlight as possible.

NOTE: The solar heater is to be installed between the filter and the pool water inlet, AFTER the water is filtered. The heater must come after the filter to prevent pressure buildup in the tubing.

IMPORTANT: If you are using a chlorine generator OR an in line chlorinator, it must be connected in-line following the solar heater to prevent damage to the heater.

CAUTION: BEFORE LOOSENING ANY THREADED CONNECTIONS ON YOUR FILTER, PUMP OR POOL, BE SURE THAT THE SUCTION AND PRESSURE HOSES ON THE FILTER ARE CLOSED OR BLOCKED TO PREVENT WATER FLOW. DO NOT ATTEMPT TO MOVE OR REPOSITION THE HEATER WHILE THE PUMP IS ON AND THE HEATER IS PRESSURIZED.

FOR BEST RESULTS: To reduce heat loss, use a pool cover on your pool overnight, run your filter system during daylight hours and cover the solar heater at night (if running the system).

3. PARTS LIST/REFERENCE

Main Unit (1)

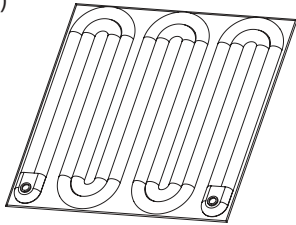

Hose Connector With O-Ring (2)

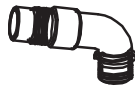

1 1/4"-1 1/2" Hose Reducer (2)

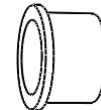

Adapter with O-Ring for INTEX® Pools (2)

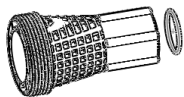

Only used with 2 1/4" diameter threaded hoses

~ OR ~

Adapter with O-Ring for BESTWAY® Pools (2)

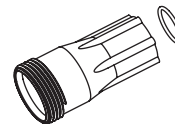

Only used with 2 1/4" diameter threaded hoses

Flat Gasket (2)



Hose Clamp (2)



Hose (1)

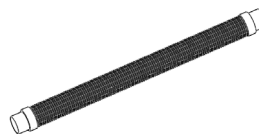

Owner's Manual

Note: Some parts may be pre-installed at the factory. Parts not shown to scale.

4. INSTALLATION INSTRUCTIONS

Heater – Filter – Pool Layout

The system layouts below will help you install the solar heater(s) to your above ground pool.

BEFORE INSTALLING SOLAR HEATER

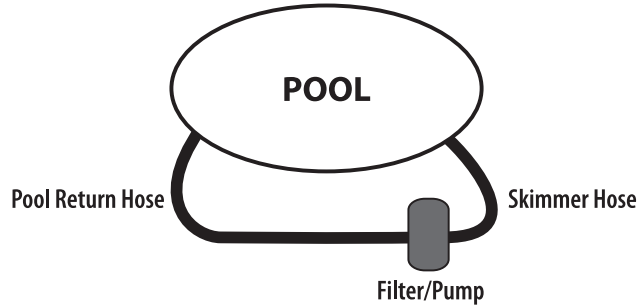

AFTER INSTALLING SOLAR HEATER

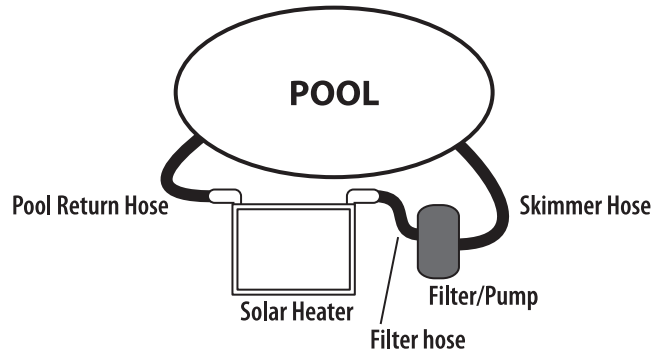

NOTE: *Not shown to scale*

Heater - Pool Connections

These instructions assume that the pool and filter system are already assembled and there is a hose attached to the pool return (pool water inlet).

Place the solar heater in a location where it will receive the greatest amount of sunlight and at least 10 feet away from pool.

1) Heater - Filter Pump Connection

- a) Turn off filter pump.
- b) Block water flow at both the pool return inlet and the filter pump outlet to prevent water from flowing through the hoses.
- c) Detach the pool return hose from your filter system and set aside.

NOTE: If you are using an INTEX® filter, remove the hose adapter from the filter port as well.

- d) Depending on the orientation of your pump setup and desired heater placement, choose one side to be the inlet and the other to be the outlet.
- e) Clear ground around the area where heater will be oriented. Remove all sharp objects, such as rocks and sticks, and lay down a tarp or other ground cover (recommended).
- f) Unfold heater and position where desired.
- g) Locate long filter hose and attach between pump (the port where the pool return hose was previously connected) and the inlet using the included hose clamps.

2) Heater – Pool Connections

Pools with 1¼" or 1½" Diameter Unthreaded Hoses

Using a hose clamp, secure the loose end of your existing pool return hose to the outlet of the heater. See Figure 1.

Pools with 2¼" Diameter Threaded Hoses

For Pools that use 2¼" threaded hoses, contact GAME Customer Service at 1.888.339.2546 (press 135 at any time).

1. Attach the adapters for either Intex or Bestway to the hose connectors. Make sure the o-ring is in the adapter prior to attachment (see Figure 1).
2. Screw your existing pool return hose onto the adapter. Be sure to place the thick connector gasket between the hose and the adapter for a tight seal.

3) Solar Heater Placement

Choosing a position which receives maximum sun exposure, face the heater in the direction of the sun's natural path.

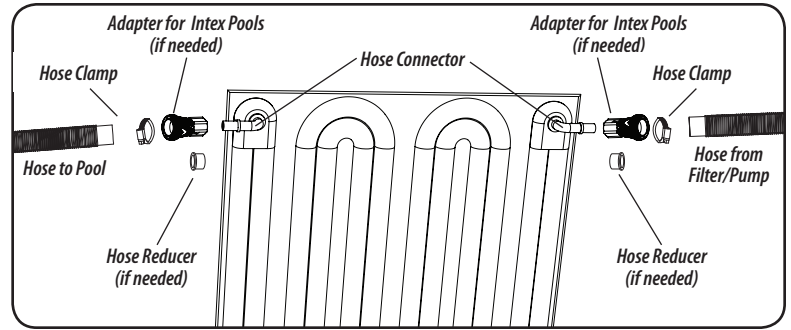

Figure 1 - Intex Pools

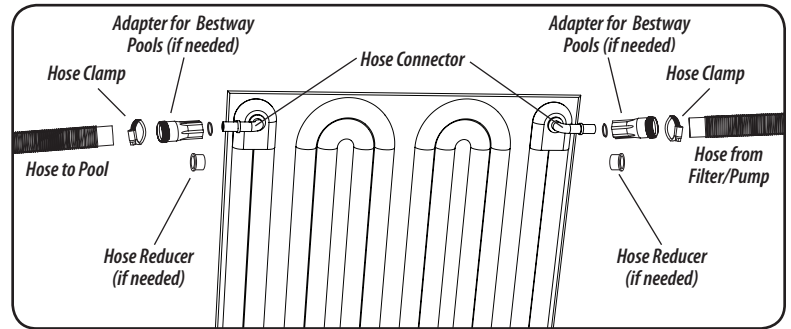

Figure 1 - Bestway Pools

NOTE: If solar heater needs to be further from the filter than the hoses allow, you may need to purchase a longer hose with the 1½" diameter openings. A 1½"-1½" hose reducer is needed to allow you to connect an additional hose if necessary (included). In this case make certain you have two hose clamps to secure the hoses to the reducer.

IMPORTANT: For maximum product life and effectiveness, do not use when outside temperatures are under 45°F or over 95°F.

CAUTION: ENSURE ALL HOSE CONNECTIONS ARE TIGHT AND THE HOSES ARE NOT KINKED OR BENT AT SEVERE ANGLES. IF THE HOSES ARE LEAKING, CHECK TO MAKE SURE ALL OF THE PARTS THAT HAVE O-RINGS HAVE THEM ATTACHED AND ARE SCREWED ON TIGHTLY. DO NOT OVER TIGHTEN HOSE CLAMPS (35 IN/LB MAX TORQUE).

5. INITIAL OPERATION

Once the solar heater has been assembled and the hoses are connected to the filter pump and pool return, unblock the flow of water into the pool return hose and turn on the pump and filter system. Bubbles will shoot out of the return nozzle into the pool initially while air is pushed out of the solar heater. If this persists for longer than 2 or 3 minutes, check for and repair any leaks in the hoses or connections.

FOR BEST RESULTS: To reduce heat loss, use a pool cover on your pool overnight, run your filter system during daylight hours and cover the solar heater at night (if running the system).

6. MAINTENANCE

The solar heater should not require servicing or maintenance other than winterizing. Prior to the first frost, or at the end of your swim season, the solar heater should be removed from its connections to the pool and stored in a frost free location.

Winterizing

Drain all the water from the solar heater by disconnecting the tubes. Store in a location protected from frost.

CAUTION: DO NOT ALLOW STANDING WATER INSIDE THE SOLAR HEATER TO FREEZE. WATER EXPANDS AS IT FREEZES AND CAN RUPTURE THE SOLAR COILS ON THE HEATER.

7. TROUBLESHOOTING

| Problem | Possibilities/Solutions |
|---|--|
| Does not appear to be heating the pool | <ul style="list-style-type: none">• Check to make sure that water is flowing through the water channels. Check the flow strength at the pool inlet.• Has it been sunny?• Put your pool cover on at night to prevent heat loss.• Additional heaters and bypass kit may be necessary. |
| No initial bubbling after heater is connected and pump is on | <ul style="list-style-type: none">• Check the setting of the filter to make sure it is returning water to the pool through the pool water inlet.• Check flow rate. |
| Bubbles continue to flow out of the pool water inlet well after the pump has been turned on | <ul style="list-style-type: none">• Check the connections for a suction leak.• Check to make sure the flow rate is normal.• There could be a break in the tubing.• There could be a clog in the tubing, try to purge out the clog. |
| Dripping or leaking from connectors | <ul style="list-style-type: none">• Check the connector seals and o-rings and replace or repair if defective.• If the heater is punctured, use the included repair kit, or a kit made for PVC pool or waterbed repair, to patch the puncture.• Tighten the elbow connectors by hand.• Coat all seals and o-rings with a thin layer of gasket lubricant, available at your local hardware or pool store. |
| High pump pressure | <ul style="list-style-type: none">• Flow through heater may be too high. A bypass kit may be needed.• Filter may need to be replaced, cleaned or backwashed.• Pool/spa system valves may need adjusting.• Water return outlet may be blocked. |

8. LIMITED WARRANTY STATEMENT

The manufacturer warranties safe operation and reliability only under the following conditions:

- The solar heater is installed and operated according to the assembly and operating instructions.
- Only original replacement parts are used.
- Consumable parts do NOT fall under the warranty.

General Terms

This Limited Warranty applies to the enclosed product (the "Product") distributed by Great American Duck Races, Inc., an Arizona corporation (doing business as Great American Merchandise and Events) ("GAME").

GAME warrants that the Product will be free from defects in materials and workmanship under normal use for a period of ninety (90) days from the date of purchase. (Your dated sales or delivery receipt, showing the date of your Product purchase, is your proof of the purchase date.) During the warranty period, GAME will repair or replace any defective parts at no charge.

All defective parts that are replaced by GAME will be replaced, at GAME's discretion, with either new parts or used parts that meet or exceed performance specifications for new parts. All parts removed from the Product under this warranty will become the property of GAME. Repair or replacement of any parts will not serve to extend the ninety (90) day warranty period.

This Limited Warranty does not apply to expendable parts. This Limited Warranty does not extend to any product (a) from which the serial number has been removed or (b) that has been damaged or rendered defective (i) as a result of accident, misuse, abuse or other external causes; (ii) by operation outside the usage parameters stated in the Instruction Sheet that shipped with the Product; (iii) by the use of parts not manufactured or sold by GAME; or (iv) by modification or service by anyone other than GAME or an authorized GAME distributor.

If a defect is identified within the warranty period, please contact GAME.

EXCEPT FOR THE LIMITED WARRANTY SET FORTH ABOVE, GAME EXPRESSLY DISCLAIMS ALL OTHER WARRANTIES, WHETHER EXPRESS OR IMPLIED, ORAL OR STATUTORY (INCLUDING, WITHOUT LIMITATION, WARRANTIES OF MERCHANTABILITY AND FITNESS FOR A PARTICULAR PURPOSE). ANY IMPLIED WARRANTIES THAT MAY BE IMPOSED BY LAW ARE LIMITED TO THE TERMS OF THE ABOVE LIMITED WARRANTY.

Limitation of Liability

EXCEPT FOR THE LIMITED WARRANTY DESCRIBED ABOVE, IN NO EVENT WILL GAME HAVE ANY LIABILITY OF ANY KIND WHATSOEVER (WHETHER UNDER CONTRACT, TORT, OR ANY OTHER THEORY OF LEGAL LIABILITY) TO ANY PERSON WITH RESPECT TO THE PRODUCT (INCLUDING, WITHOUT LIMITATION, (A) ANY USE OR MISUSE OF THE PRODUCT, (B) ANY FAILURE OR MALFUNCTION OF THE PRODUCT, (C) ANY BODILY INJURY, DEATH, LOSS OF OR DAMAGE TO ANY PROPERTY, OR ANY OTHER DAMAGES RELATED TO OR RESULTING FROM THE PRODUCT OR ITS USE (INCLUDING, WITHOUT LIMITATION, ANY SPECIAL, INCIDENTAL, CONSEQUENTIAL OR PUNITIVE DAMAGES, LOST PROFITS, LOSS OF USE), EVEN IF GAME OR GAME'S AUTHORIZED REPRESENTATIVES HAVE BEEN ADVISED OF THE POSSIBILITY OF ANY SUCH DAMAGES.

TO OBTAIN WARRANTY SERVICE, PLEASE CALL, WRITE, OR EMAIL US DIRECTLY AT THE ADDRESS SHOWN BELOW.

THIS WARRANTY GIVES YOU SPECIFIC LEGAL RIGHTS, AND YOU MAY ALSO HAVE OTHER RIGHTS WHICH VARY FROM STATE TO STATE.

Severability

Any provision of this Limited Warranty which is prohibited or unenforceable in any jurisdiction will, as to such jurisdiction, be ineffective to the extent of such prohibition or unenforceability without invalidating the remaining portions hereof or affecting the validity or enforceability of such provision in any other jurisdiction.

Venue and Choice of Law

This Limited Warranty is applicable in all countries. This Limited Warranty will be governed by the laws of the State of Arizona (regardless of any conflict of laws rules), and any disputes arising from this Limited Warranty will be resolved in Phoenix, Arizona.

Entire Agreement

This Limited Warranty is understood to be the complete and exclusive agreement between GAME and the purchaser of the Product, superseding all prior agreements, oral or written, and all other communications between such parties relating to the Product. No employee or representative of GAME or any other party is authorized to make any warranty in addition to the limited warranty set forth above.

To obtain warranty service, please call, write, or email us directly at the address shown below.

This warranty gives you specific legal rights, and you may also have other rights which vary from state to state.

**IMPORTANT
DO NOT RETURN PRODUCT TO STORE**

For technical assistance and missing parts, call Customer Service toll-free

1.888.339.2546

(press 135 at any time)

Monday through Friday, 8:00 am to 5:00 pm MST

Please visit our website, www.game-group.com, for potential updates to these instructions.

9. APPENDIX: EXPLODED PARTS DIAGRAM

| Key Part Name | Qty |
|---|-----|
| 1 Main Unit | 1 |
| 2 Adapter for Intex OR Adapter for Bestway Pools | 2 |
| 3 Hose Clamp | 2 |
| 4 Long Hose | 1 |
| 5 Hose Connector with O-Ring | 1 |
| 6 Hose Reducer | 2 |

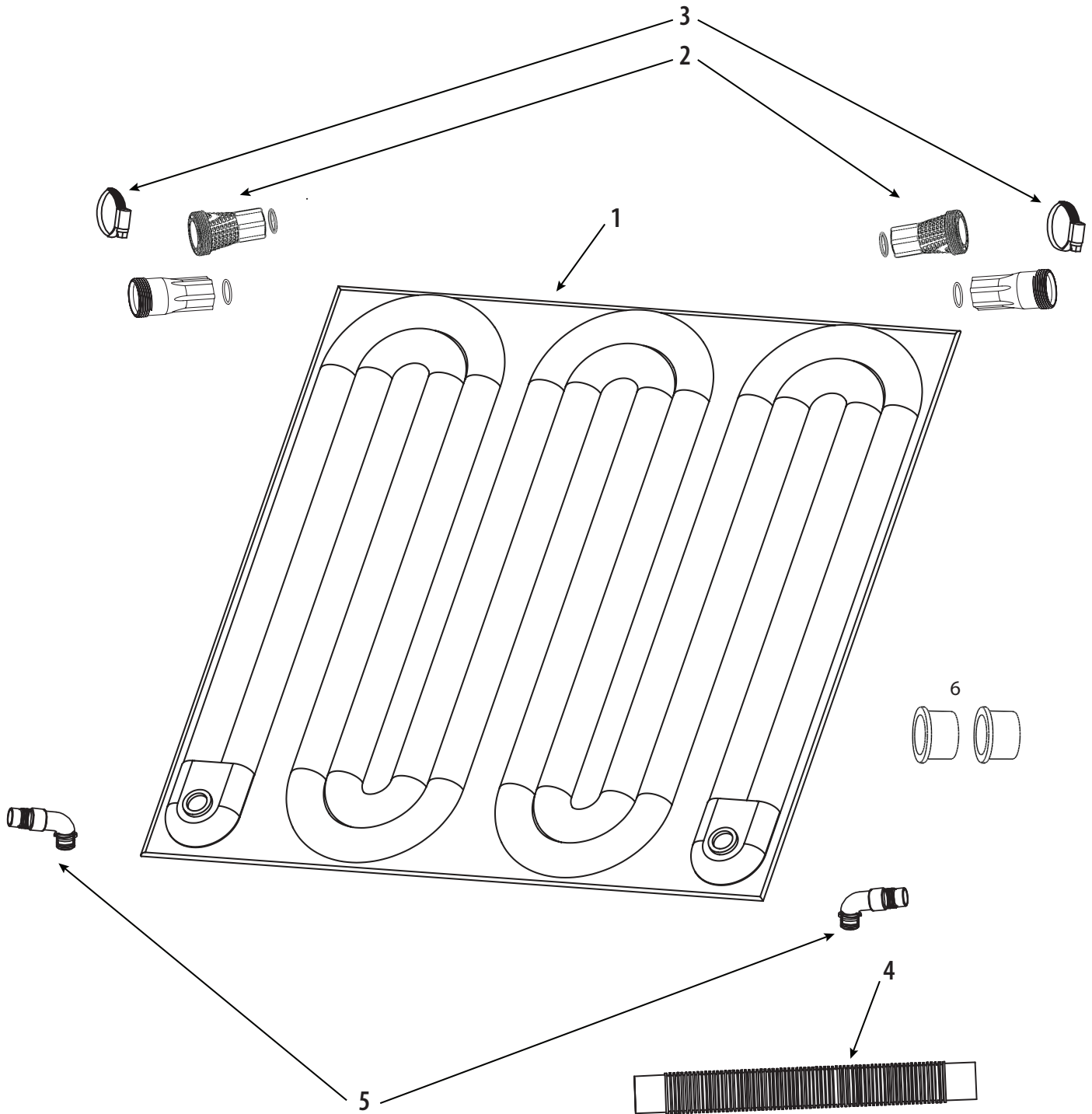

IMPORTANT
DO NOT RETURN PRODUCT TO STORE

For technical assistance and missing parts, call Customer Service toll-free

1.888.339.2546

(press 135 at any time)

Monday through Friday, 8:00 am to 5:00 pm MST

Please visit our website, www.game-group.com, for potential updates to these instructions.

**Look for other GAME products at your favorite store
or visit our website, www.game-group.com.**



/GAMEproducts



Great American Merchandise & Events™
16444 N. 91st Street
Scottsdale, AZ 85260-1567 U.S.A.

tel: 888.382.5988, 602.957.3825
fax: 602.957.7665
email: products@game-group.com
www.game-group.com/retailers

Intex® is a registered trademark of Intex Recreation Corp. GAME is not affiliated with, sponsored by, or otherwise associated with Intex Recreation Corp.

Bestway® is a registered trademark.